

Hotel Service

Optimised day-to-day hotel processes



wanzl

INNOVATION
MADE BY WANZL

CREATIVE CENTER
wanzl

Contents

A SUCCESS STORY	5		
HIGHLIGHTS_MADE BY WANZL	6		
UPDATE YOUR HOUSEKEEPING	7		
OVERVIEW	9		
01 HOUSEKEEPING	10		
Housekeeping trolleys	12		
⁰¹ Mundus	12		
⁰² Basic	24		
⁰³ Tantum 9	26		
Supplementary housekeeping products	28		
⁰⁴ hotel-max	28		
⁰⁵ SW 80 handcart	30		
⁰⁶ SW KX handcart	32		
⁰⁷ LT 240 handcart	34		
⁰⁸ KS 600 luggage stands.....	35		
⁰⁹ RCW room-change trolley	36		
¹⁰ GR clothes stands	37		
¹¹ X-Bed additional bed.....	38		
Roll cages and transport baskets	40		
¹² AL sprung-base trolley	40		
¹³ AL shelved laundry container	41		
¹⁴ KT3 shelved laundry trolley	42		
¹⁵ TK-R · TK-D	43		
¹⁶ RC/N1	44		
¹⁷ RC/N2	45		
02 FRONT OFFICE	46		
Luggage collection trolleys	48		
⁰¹ Premium GS-Trend	48		
⁰² GS-Lobby	50		
⁰³ GS-Group	51		
⁰⁴ GS-Compact	52		
Luggage transport trolleys	53		
⁰⁵ Aera 300 L	53		
⁰⁶ Travel 300	54		
Guidance systems	55		
⁰⁷ Part Flex 2000	55		
⁰⁸ Part Line 2000	56		
03 FOOD + BEVERAGE	58		
Service and serving trolleys	60		
⁰¹ MBW Smart	60		
⁰² MBW Secure	62		
⁰³ RSVC Comfort room service table.....	64		
⁰⁴ EG 300 serving trolley · EU 300	66		
Bottle trolley	67		
⁰⁵ FW 6 · FW 8 · FW 12	67		
04 STORAGE + SHELVING	68		
Service shelves	70		
⁰¹ wire tech 100	70		
⁰² High Rack	72		
Transport trolleys	74		
⁰³ T25	74		
⁰⁴ SP2	75		
05 ACCESS SOLUTIONS	76		
06 MINI MARKETS 24/7	80		



Wanzl Hotel Service

Continuing a long success story

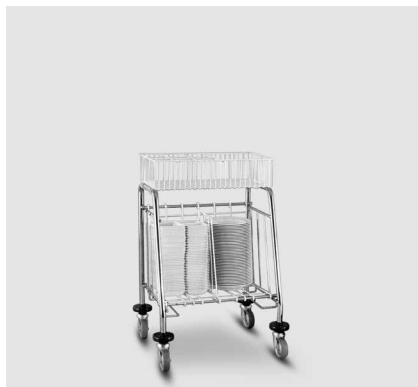
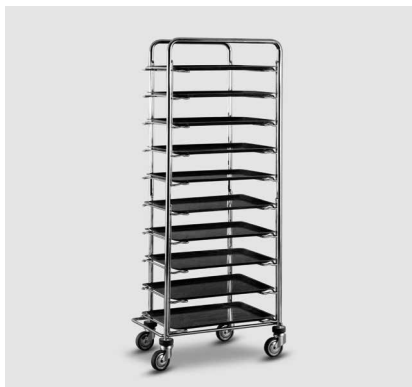

PLATE TROLLEY 1976



TRAY TROLLEY 1984



ZP CLASSIC HOUSEKEEPING TROLLEY 2012

■ **At Wanzl, we know what** people will want tomorrow. As a world market leader for shopping trolleys, we also provide the right solutions for hotel service. As early as the 1970s, the first Hotel Service products emerged, such as the plate and tray trolleys to optimise day-to-day processes in the hotel and catering trade.

■ **Today, Wanzl employs** over 4,600 people at twelve production sites worldwide, working on new business areas and products, on exceptional product designs with a consistently high quality and a vast production range. The aim: perfectly satisfied customers.

***The world is changing.
Take advantage of it!***

■ **For optimised day-to-day hotel processes.** With its professional competence, Wanzl ensures effective work processes in the hotel and catering trade – and thus also the competitiveness and business success of its partners. Functional, economical and user-friendly products minimise personnel requirements and help to satisfy the high expectations and requirements of your guests.

Highlights_MADE BY WANZL

Innovative products from a single source



IN-HOUSE CASTOR PRODUCTION



IN-HOUSE CAD DEVELOPMENT

Production

■ **Wanzl sets the standards for production.** In all areas of production Wanzl's quality policy results in products made from the best materials with first-class workmanship and well-finished surfaces. This ensures long-term maintenance-free use and investment security.

Quality

■ **Wanzl sets the standards for quality** – particularly with regard to smooth motion: the castors are mounted on two maintenance-free ball bearings, have abrasion proof treads and feature steering forks with ball bearings. As a result, our housekeeping trolleys are quiet, smooth running and easy to steer.

Innovation

■ **Wanzl sets the standards for innovation** – practical solutions from practical experience:
Using state-of-the-art production and design technology, we create innovative, future-oriented products - consistently setting new standards for handling and efficiency.

Update your housekeeping

As individual as your guests



OUR EXPERTS TAKE THE TIME THAT YOU NEED

■ Our services:

- Personal consultation with our team of experts
- Easy to reorder spare parts
- 36 months' warranty on Wanzl castors
- 10-year availability guarantee
- Dense service partner network
- Made in Germany

What is important to you?

*Stability – durability – design – customisation –
robustness – price – size – flexibility*

■ Benefit from our experience and provide your housekeeping with the best equipment.

Our products are designed for hotel-specific challenges and conditions and provide your staff with optimal support. Especially with our housekeeping trolleys, we always have a suitable trolley for the varied requirements of the establishment. Whether standard, flexible or customised housekeeping trolley – working efficiently is not a question of price. Let us help you find your favourite products. Tell us about your needs, problems and challenges and we will work out a suitable product selection together.



01 Housekeeping

02 Front Office

03 Food + Beverage

04 Storage + Shelving

05 Access Solutions

06 Mini Markets 24/7

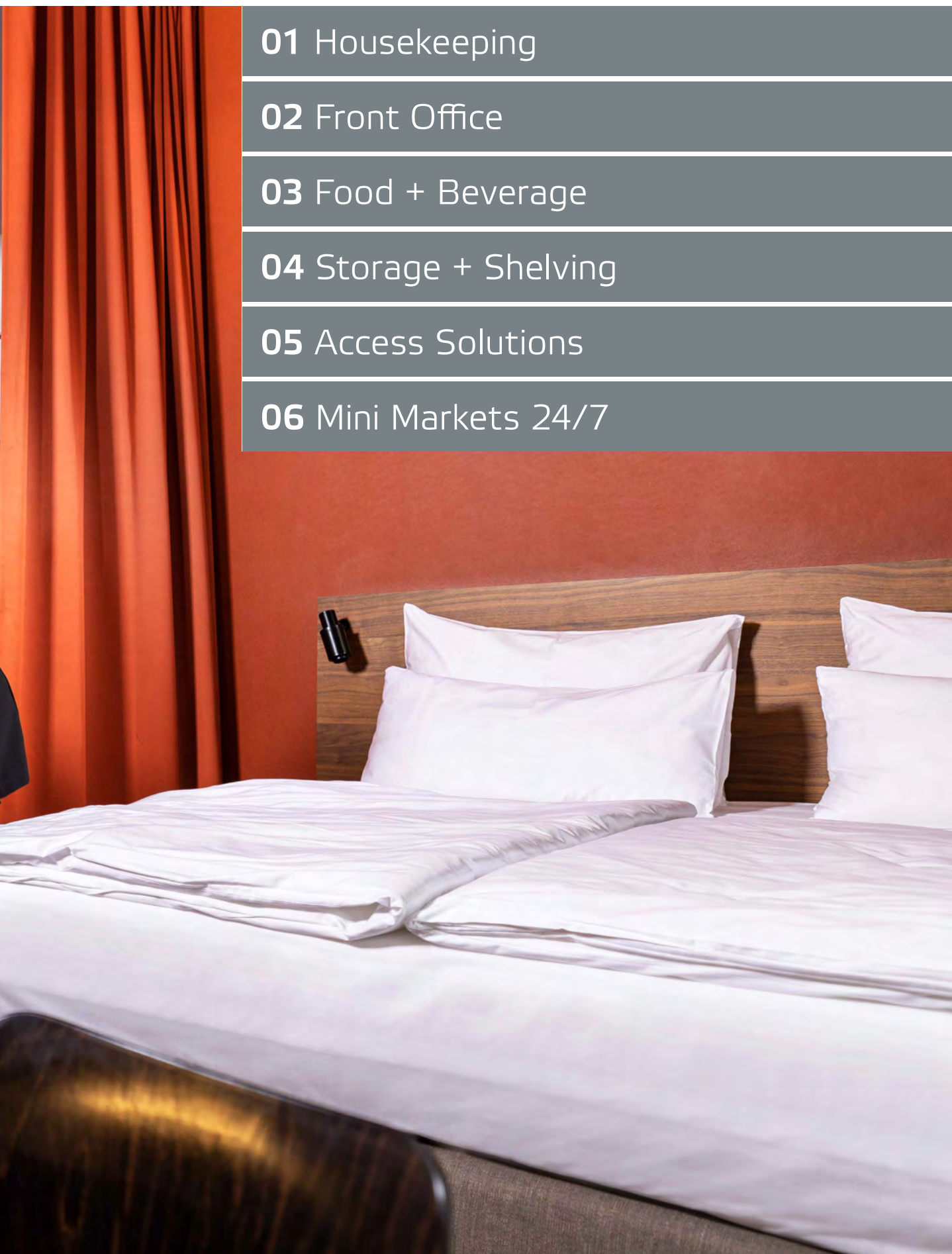

01 Housekeeping



01 Housekeeping



Optimised housekeeping and efficient laundry flows

■ **Whether it's a 5-star hotel, a wellness oasis or an idyllic country inn,** Wanzl Hotel Service's wide range of trolleys meets every requirement for first-class service.

The individuality of each hotel is also reflected in Wanzl's hotel trolleys. The Mundus housekeeping trolley in particular can be adapted to the requirements and design of the hotel.

Both clean and dirty laundry must be transported – Wanzl offers optimal solutions for this. Optimise your laundry flows with our handcarts, shelved laundry trolleys and roll cages.

01.01 Mundus®

**THE FLEXIBLE
ALL-ROUNDER**

Now even more versatile in its use

- > Individual combination options
- > Agile and easy to manoeuvre thanks to the hybrid design
- > Furniture protection with integrated deflectors and bumper profiles



MUNDUS 9
Anthracite finish
Metallic black frame colour
Illustration shows optional equipment

Effective protection
Non-marking deflectors on the frame and side sections protect against damage to the interior decor.



MUNDUS 5



MUNDUS 7



MUNDUS 9



MUNDUS 11

01.01 Mundus® housekeeping trolley

■ **Housekeeping, reinvented.** Create a custom housekeeping trolley to suit your needs. You can also choose “your design” from three frame colours, two textile colours and three finishes and combine them with each other – entirely according to your taste.

Alternatively, two variations of the Mundus as classic variants are available for dispatch within five working days.



Aluminium structure

The Mundus has a new, closed structure made of aluminium, and is available in the frame colour of your choice.



Shelf mounting

Thanks to the newly developed mounting, the shelves are easily height-adjustable and can also be securely fixed when the ground is uneven.

Hybrid design: Steel tube base combined with aluminium profiles. e.g. with fold-out bars for hanging laundry sacks and rubbish bags, and one bar with a folding leather cover to conceal a 120 or 50 litre plastic bag. Lower bars each come with grids and two height-adjustable removable shelves in matching finish.

Finish: Frame with plastic-powder coating.

Castors: Mundus 9 and 11: 4 swivel castors with polyamide tread, diameter 200 mm, 5th castor in the centre with rubber tread, diameter 160 mm.

Mundus 7: 2 swivel castors, 2 fixed castors with polyamide tread, castor diameter 200 mm.

Mundus 5: 2 swivel castors, 2 fixed castors with rubber tread Ø 125 mm.

■ **The Mundus is highly customisable** and always boasts surprisingly varied new looks. This means that each basic model can be turned into an individual item that takes the aspirations of a company and its corporate identity personally.

01.01 Choose your size

Mundus 5

Dimensions (mm):
 Castors diameter 125
Load-bearing capacity:
 Trolley shelves:
 maximum 50 kg each
 Trolley side sections:
 maximum 20 kg each

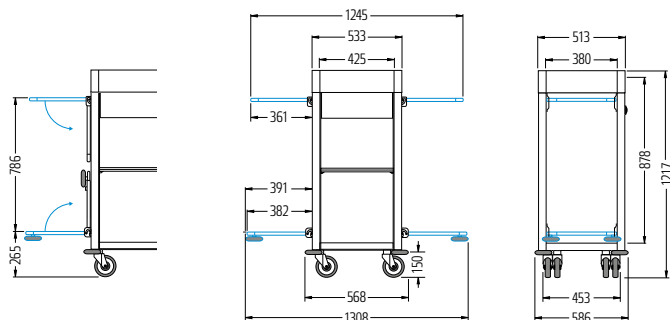

Mundus 7

Dimensions (mm):
 Castors \varnothing 200
 Nova castor diameter 100
Load-bearing capacity:
 Trolley shelves:
 maximum 50 kg each
 Trolley side sections:
 maximum 20 kg each

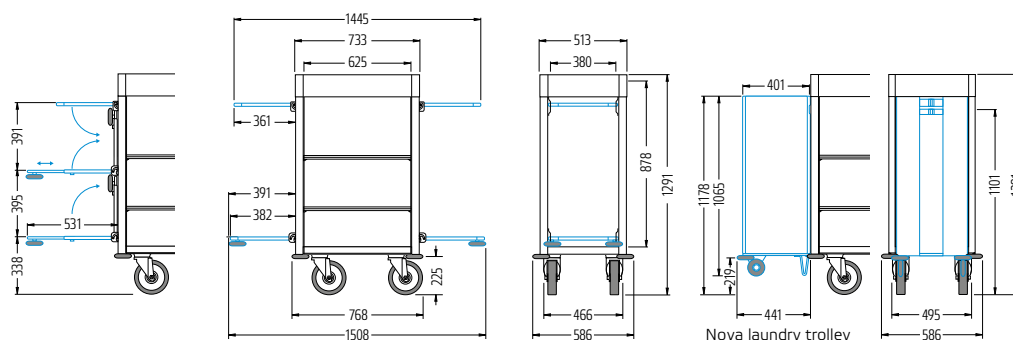

Mundus 9

Dimensions (mm):
 Castors diameter 200,
 5. castor diameter 160
 Nova castor \varnothing 100
Load-bearing capacity:
 Trolley shelves:
 maximum 50 kg each
 Trolley side sections:
 maximum 20 kg each

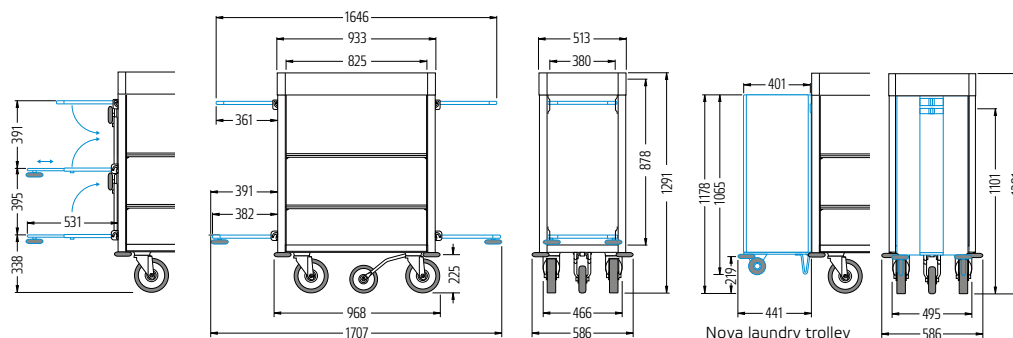

Mundus 11

Dimensions (mm):
 Castors diameter 200,
 5. castor diameter 160
 Nova castor \varnothing 100
Load-bearing capacity:
 Trolley shelves:
 maximum 50 kg each
 Trolley side parts:
 maximum 20 kg each

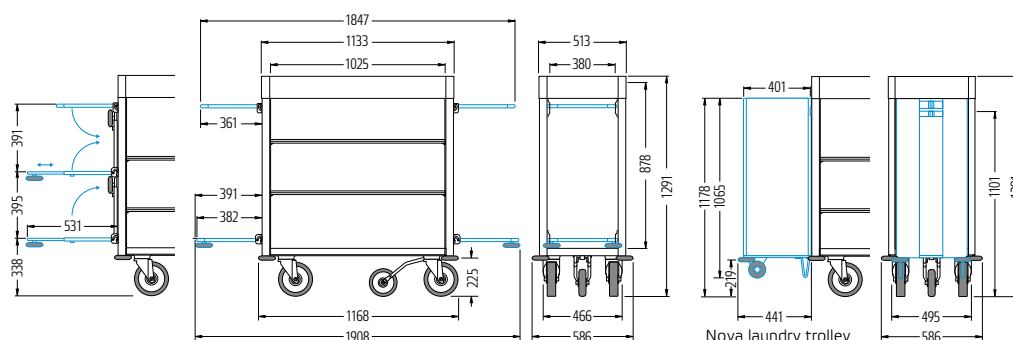

01.01 Mundus®

WAREHOUSE
PROGRAMME

Ideal helper in two sizes

- > Ready for dispatch within 5 working days
- > Our classics in 2 sizes
- > For last-minute decisions and rush orders



MUNDUS 9 CLASSIC
04.08030.95-V329



MUNDUS 11 CLASSIC
04.08035.95-V160

Mundus 9 Classic

Finish: Grey anthracite

Frame colour: Metallic black

Structure: New aluminium structure

Left: Polyester bag

Right: Rubbish bag holder with cover

2 shelves: Grey anthracite

Mundus 11 Classic

Finish: Grey anthracite

Frame colour: Metallic black

Structure: New aluminium structure

Left: Polyester bag

Right: Rubbish bag holder with cover

2 shelves: Grey anthracite

■ **Our decades of experience** paired with elegant, timeless design – these classic trolleys are equipped to meet our customers' most common requirements.

01.01 Mundus®

**FAST DELIVERY
PROGRAMME**

Plenty of scope for customisation with fast delivery

- > Ready for dispatch within 15 working days
- > Custom combination with selected accessories
- > For those looking for a customised housekeeping trolley

■ **With the fast delivery programme**, you can now receive a new Mundus within a short time, and still have customisation options. Ready-assembled trolleys in four sizes are available and can be supplemented with

selected accessories and add-on parts according to personal requirements. An ideal solution for use in hotels, ships or similar facilities.

4 sizes

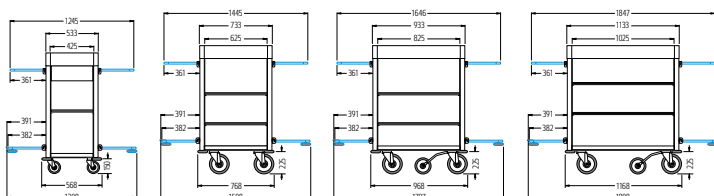

2 finishes



NATURAL OAK



ANTHRACITE

2 frame colours

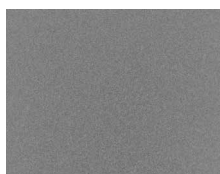

TITANIUM GREY

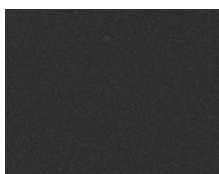

METALLIC BLACK

1 textile colour



ANTHRACITE

What configuration options do I have in the fast delivery programme?

1. Select one of the four sizes.
2. There are two finishes and two frame colours to choose from, which can be combined according to your taste.
3. Then select the optimal side panels and accessories for your applications – we'd be delighted to advise you!



01.01 Mundus® side panels and accessories in the fast delivery programme

Dirty laundry bag holder

Standard or with an elegant fabric covering.



Rubbish bag holder

Fold-out bar for hanging a plastic bag, with folding leather cover for closing.



Cleaning tray holder

Transport cleaning materials safely with the cleaning tray holder.



Wire rack

Effective protection for your interior thanks to deflectors.



Waste separation box

Simple waste separation: 2 stackable boxes with a lid allow easy separation of different recyclable materials.



Mop holder 20–30 mm

The user-friendly, flexible holder system keeps everything under control.



Fabric covering

Secured with Velcro visually and functionally perfect. The colour anthracite can be selected.



Mundus utensils pocket

Accessories for even more space: For transporting additional utensils.



Small items box

For even better organisation: Clear arrangement of guest supplies Made of wood, painted light pearl grey.



SmartFix mobile phone holder

For all common smartphones: The lockable holder enables digital housekeeping.



01.01 Mundus®

Personalised single items for every requirement

INDIVIDUAL
CONFIGURATION

- > Choice of a wide range of accessories
- > Customer-specific requests
- > For those wanting to create their very own Mundus

Individual configuration for optimum functionality:

With the Mundus, the cleaning equipment can be perfectly adapted to personal needs. The free choice from all available accessories and add-on parts, colours and finishes gives you the opportunity to perfectly match your

trolley to your requirements. Whether you require special storage or cleaning compartments or would like to pursue a specific colour concept – with our individually configurable housekeeping trolley, there are no limits.

4 sizes

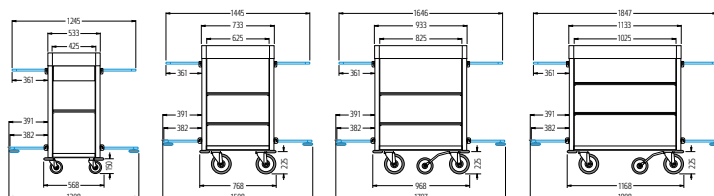

3 finishes



MAHOGANY

NATURAL OAK

ANTHRACITE

3 frame colours

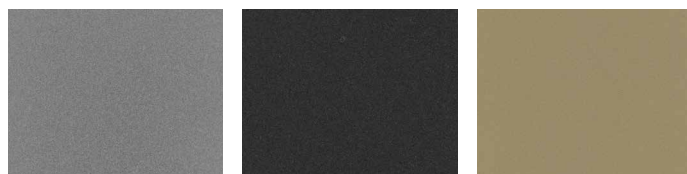

TITANIUM GREY

METALLIC BLACK

METALLIC GOLD

2 textile colours

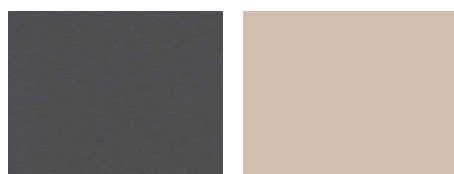

ANTHRACITE

BEIGE

How do I create my own Mundus?

1. Select one of the four sizes.
2. There are 3 finishes and 3 frame colours to choose from, which can be put together to suit your taste.
3. Depending on the application, you can further customise the trolley's body, e.g. with drawers or a roll-down panel.
4. Then select the optimal side panels for your applications – we'd be delighted to advise you!
5. Now your personalised Mundus is ready – our accessories add the finishing touches.



01.01 Chassis of the Mundus®

■ **The exterior features of the Mundus** match perfectly with the high quality it demonstrates in its design, equipment and accessories. The whole trolley is made of robust steel which ensures high load capacity and stability, while the all-round profiles are made from aluminium. Its hybrid structure makes the compact Mundus truly lightweight.

Structure

The Rehling variant provides a more open design and makes it easy to push the trolley.



Structure with leather cover

High-quality fibreglass reinforced leather cover. Double-stitched edges increase durability.



Standard drawer

Lockable option available. The removable pull-out drawer with soft closing and variable compartment dividers provides additional storage space.



3P drawer

Push & pull. Two additional storage compartments for image brochures and documents. Practical clipboard for checklists.



Standard shelves

Variable shelves: The shelves in anthracite can be easily and conveniently inserted at different heights without additional tools.

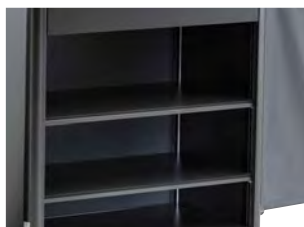

Shelves for variant with roll-down panel

Customisable solutions: Special shelves for variants with lockable roll-down panel.



Aluminium profile

Lightweight design: The Mundus is easy to manoeuvre thanks to its aluminium profile.



Lockable roll-down panel

The roll-down panel and an RFID lock protect the contents of the trolley from unauthorised access. Only available in combination with a standard drawer!



5th castor – easy to manoeuvre

Simply ingenious: the 5th castor allows the trolley to turn on the spot.

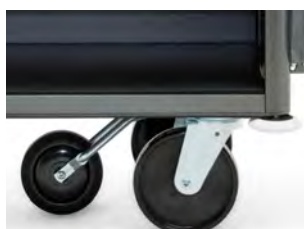

Protection for your interior

Protective feature: Rubber deflectors protect the hotel interior.



01.01 Customise the side sections

■ **Equipment for the Mundus** can be configured individually. Nothing is off the rack, it is all tailor-made. The trolley comes with a long list of practical equipment. Optimise the Mundus basic equipment with freely selectable add-on parts and make it possible for the

hotel's individual requirements to be met. Thanks to the smart modular design, all side add-on parts can be fixed or replaced at any time in just a few simple steps. After attachment, the safety screws ensure a firm fit even under high loads.

Dirty laundry bag holder

Standard or with an elegant fabric covering.



Leather cover for dirty laundry bag holder

Clean solution:
On request, with folding leather cover for closing



Drawer compartment divider

Variable compartment dividers organise guest supplies.



Nova laundry trolley

The laundry trolley can be detached from the Mundus using a handle, allowing it to be taken into rooms separately.



Wire rack

Effective protection of your interior thanks to deflectors.



Removable tray

Pull-out trays for customised storage space.



Holder for rubbish bag / double rubbish bag

Fold-out bar for hanging a plastic bag, with folding leather cover for closing.



Closed tray

For sufficient storage space on the Mundus.



Fabric covering

Secured with Velcro visually and functionally perfect. The colour anthracite can be selected.



Push handle

Simple and comfortable operation in confined spaces thanks to the optional push handles.



01.01 Accessories – Mundus® even more unique

■ **The Mundus housekeeping trolley** can be expanded with practical accessories if desired. The mop holders, laundry bags and waste separation boxes are just some of the optional features available to make housekeeping easier.

Waste separation box

Simple waste separation:
2 boxes allow easy separation of different recyclable materials.



Mop holder

The user-friendly and flexible holder system in two sizes keeps everything under control.



Small items box

For even better organisation:
Clear arrangement of guest supplies Made of wood, painted light pearl grey.

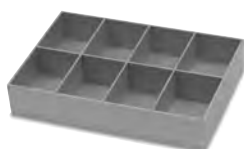

SmartFix mobile phone holder

For all common smartphones: The lockable holder enables digital housekeeping.



Polyester bag

Anthracite, easily removable.
With optional zip closure.



Mundus utensils pocket

Accessories for even more space: For transporting additional utensils.



Cleaning tray holder

Transport cleaning materials safely with the cleaning tray holder.



Disinfectant holder

For all standard disinfectant dispensers. Can be mounted on the structure as well as the Rehling variant.



Brake bar

Safety during cleaning.
The brake bar ensures that the trolley does not roll away on uneven surfaces or on a ship.



01.01 Configuration ideas

Use the Mundus even more flexibly

■ **Thanks to its customisable configuration options**, the Mundus also fulfils a wide range of other applications in addition to classic housekeeping trolleys.

Turndown trolley

With its space-saving design and practical storage compartments, the turndown trolley is easy to handle and enables housekeeping staff to work quickly and efficiently. As a smaller alternative to the classic Mundus, the turndown trolley is ideal for discreetly checking rooms again and refilling towels or amenities if necessary. This keeps sleeping areas spotless and ensures a restful stay for your guests every night.



Public area trolley

Hotel cleanliness, style and convenience – The public area trolley is a nice alternative to traditional cleaning trolleys, preventing guests from being disturbed by disruptive cleaning equipment. The trolley offers plenty of storage space for all cleaning equipment needed for thorough cleaning of public areas. From a mop and bucket to a vacuum cleaner, everything is safely and neatly stowed away.



Banquet and terrace trolleys

The banquet and terrace trolley is the perfect tool for successful events. As a service station, it offers shelves for cutlery and crockery, enabling staff to work efficiently. It also provides ample storage space for drinks and snacks. The sides of the trolley can also be used as space for labelling, for example to display the daily menu. With its elegant design, the Mundus is also a stylish accessory that enhances the ambience.



01.01 Ordering section

Models	Mundus 5	Mundus 7	Mundus 9	Mundus 11
Dimensions	533 x 586 x 1217	733 x 586 x 1291	933 x 586 x 1291	1133 x 586 x 1291
	Order no.	Order no.	Order no.	Order no.
Mundus – 3 finishes, 3 frame colours	04.08020.95-V	04.08025.95-V	04.08030.95-V	04.08035.95-V

Body				
Standard shelves, anthracite finish, 2 pieces	77.51839.95-0009	77.75406.95-0009	77.39924.95-0009	77.75293.95-0009
Shelves for variant with roll-down panel, anthracite finish, 2 pieces	77.42415.95-0009	77.10097.95-0009	77.09984.95-0009	77.09871.95-0009
Standard drawer	77.34505.95-XXXX	77.33940.95-XXXX	77.33262.95-XXXX	77.33601.95-XXXX
Standard drawer, lockable	77.34392.95-XXXX	77.34053.95-XXXX	77.33375.95-XXXX	77.33714.95-XXXX
3P drawer (Mundus 7: only with clipboard)	-	77.80614.95-XXXX	77.81066.95-XXXX	77.81405.95-XXXX
3P drawer, lockable	-	77.80840.95-XXXX	77.81179.95-XXXX	77.81518.95-XXXX
Roll-down panel, lockable, only in combination with standard drawer	77.36878.95-0000	77.36652.95-0000	77.21284.95-0000	77.36765.95-0000
Structure	77.51080.95-XXXX	77.49837.95-0000	77.48142.95-0000	77.49159.95-0000
Cover for structure	77.50063.95-0000	77.49385.95-0000	77.48481.95-0000	77.48707.95-0000
Bonded-on rubber castors, set, 200 mm (Mundus 7: 2 fixed / 2 swivel castors)	-	60.72925.00-0000	60.72699.00-0000	60.72699.00-0000
Identical width castors, set, 200 mm	-	60.45776.00-0000	60.45776.00-0000	60.45776.00-0000

Side panels				
Standard soiled laundry sack holder	77.73264.95-XXXX	77.73264.95-XXXX	77.73264.95-XXXX	77.73264.95-XXXX
Soiled laundry sack with fabric covering	77.11900.95-XXXX	77.11900.95-XXXX	77.11900.95-XXXX	77.11900.95-XXXX
Cover for soiled laundry sack holder	77.60151.07-0000	77.60151.07-0000	77.60151.07-0000	77.60151.07-0000
Detachable Nova laundry trolley, incl. fabric covering, laundry sack not included	-	77.14848.95-XXXX	77.14848.95-XXXX	77.14848.95-XXXX
Centre grid tray	77.66027.95-XXXX	77.66027.95-XXXX	77.66027.95-XXXX	77.66027.95-XXXX
Bottom grid tray	77.22861.95-XXXX	77.22861.95-XXXX	77.22861.95-XXXX	77.22861.95-XXXX
Closed bottom tray	77.15362.95-XXXX	77.15362.95-XXXX	77.15362.95-XXXX	77.15362.95-XXXX
Closed top tray	On request	On request	On request	On request
Standard rubbish bag holder, incl. cover	77.23087.95-XXXX	77.23087.95-XXXX	77.23087.95-XXXX	77.23087.95-XXXX
Standard double rubbish bag holder, incl. cover	77.15516.95-XXXX	77.15516.95-XXXX	77.15516.95-XXXX	77.15516.95-XXXX
Centre tray, extendable	-	77.73372.73-XXXX	77.73372.73-XXXX	77.73372.73-XXXX
Bottom tray, extendable	-	77.73711.73-XXXX	77.73711.73-XXXX	77.73711.73-XXXX
Fabric covering for each side	77.19099.95-XXXX	77.19099.95-XXXX	77.19099.95-XXXX	77.19099.95-XXXX

Accessories				
Waste separation box without cover, silver-grey plastic, 40 litre	04.06555.07-0000	04.06555.07-0000	04.06555.07-0000	04.06555.07-0000
Lid for waste separation box, silver-grey plastic	04.06668.07-0000	04.06668.07-0000	04.06668.07-0000	04.06668.07-0000
Wooden box for small items, painted light pearl grey	00.21837.78-9022	00.21837.78-9022	00.21837.78-9022	00.21837.78-9022
Mundus utensils pocket, polyester, grey	77.33267.00-0000	77.33267.00-0000	77.33267.00-0000	77.33267.00-0000
Polyester bag, anthracite, 110 litres, 1 unit	00.22402.00-0000	00.22402.00-0000	00.22402.00-0000	00.22402.00-0000
Polyester bag, anthracite, with zip fastener, 110 litres, 1 unit	77.58951.00-0000	77.58951.00-0000	77.58951.00-0000	77.58951.00-0000
Mop holder 20-30 mm	04.08815.95-0000	04.08815.95-0000	04.08815.95-0000	04.08815.95-0000
Mop holder 30-40 mm	04.08816.95-0000	04.08816.95-0000	04.08816.95-0000	04.08816.95-0000
Console for mop holder	77.67413.95-XXXX	77.67413.95-XXXX	77.67413.95-XXXX	77.67413.95-XXXX
Cleaning tray holder	77.67865.95-XXXX	77.67865.95-XXXX	77.67865.95-XXXX	77.67865.95-XXXX
Drawer compartment divider	77.32305.73-7035	77.32305.73-7035	77.32305.73-7035	77.32305.73-7035
Push handle	77.32757.95-XXXX	77.32757.95-XXXX	77.32757.95-XXXX	77.32757.95-XXXX
Universal disinfectant dispenser holder	77.62325.95-7084	77.62325.95-7084	77.62325.95-7084	77.62325.95-7084
Smartphone holder with attachment	77.68442.76-7084	77.68442.76-7084	77.68442.76-7084	77.68442.76-7084
Front brake bar with brake roller set	-	-	60.74139.00-0000	-

01.02 Basic

**THE VALUED
CLASSIC**

Housekeeping – extra economical

- > *Practical equipment*
- > *Protect your furniture with integrated deflectors*
- > *Platinum white finish*



BASIC
Platinum white finish
Illustration shows optional equipment

Effective protection
Non-marking deflectors on the frame and side sections protect against damage to the interior décor.

01.02 Basic housekeeping trolley

■ The practical features of the basic housekeeping trolley also offer the high Wanzl quality you have come to expect even for smaller budgets.



Fold-out side panels

Provide flexibility in confined spaces. A practical solution to save space.

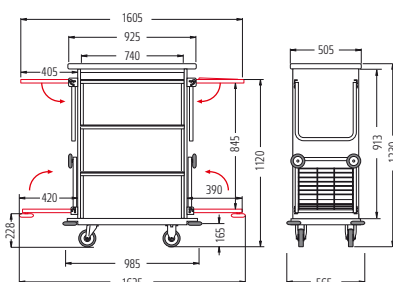

Dimensions (mm):
 Castor diameter 125
 Load-bearing capacity:
 Trolley shelves:
 maximum 50 kg each
 Trolley side sections:
 maximum 20 kg each

Standard equipment: Steel-tube design, fold-out bars for hanging laundry and rubbish bags, one of which is a bar with folding lid for closing 120-litre plastic bags.

Lower bars include grids. Three fixed shelves, platinum white finish.

Surface finish: Plastic powder-coated in titanium grey.

Castors: 2 swivel castors, 2 fixed castors with polyamide tread, castor diameter 125 mm.

Basic	Order no.
Platinum white finish	04.01240.95-0000

01.03 Tantum 9

**THE ECONOMIC
SPACE SAVER**

Robust space saver at a low price

- > *Variably adjustable wire shelves*
- > *Wooden rear panel as a privacy and dirt screen*
- > *Removable side panels for space-saving storage*



TANTUM 9

Frame in metallic black

Illustration shows optional equipment

Effective protection

Non-marking deflectors on the frame and side sections protect against damage to the interior décor.

01.03 Tantum 9 housekeeping trolley

■ In an international comparison, the **Tantum 9 housekeeping trolley is the most economical**. The model impresses with its lack of plastic parts. It is therefore more robust and hygienic. Its rear panel is made of hard-wearing, impact-resistant wood. It also serves as a screen and protection against dirt and, like the side panels and wire shelves, can be retrofitted if required. Its durability is what makes it so economical.



TANTUM 9

Frame in metallic black
Illustration shows optional equipment



Standard equipment: Solid steel structure, two height-adjustable wire shelves, as well as a U-shaped wire shelf at the top and a wooden shelf at the bottom. Two bars for hanging laundry and rubbish bags, one of which is a bar with folding lid for closing 120-litre plastic bags.

Lower bars include grids.

A high-quality laundry bag and a VE 120-litre plastic bag are included in the scope of delivery.

Surface finish: Plastic powder-coated in metallic black

Castors: 4 swivel castors, diameter 125 mm with rubber tread, plastic deflector rings.

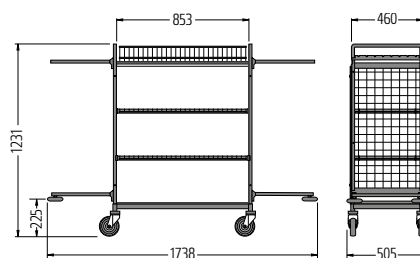

Dimensions (mm):
Castor diameter 125
Load-bearing capacity:
Trolley shelves:
maximum 50 kg each
Trolley side sections:
maximum 20 kg each

Tantum 9

Plastic powder-coated in metallic black

Order no.

04.15708.95-7097

01.04 hotel-max

For invisible housekeeping

- > *"Invisible" assistants for ensuring that housekeeping causes as little disturbance as possible*
- > *For hotels with an exclusive ambience*
- > *Compact, manoeuvrable and stylish*



HOTEL-MAX
Service trolley
with service basket

Pat. pend.

Standard equipment

hotel-max service trolley:

The chassis comprises a round tube design with a durable plastic powder coating. Utensils basket and bottom tray to hold the wire service basket.

Castors: Made of plastic with wear-resistant tread.

hotel-max service basket:

Plastic in woven willow look. Food-safe, heat-resistant to 70°C and UV stable. Washable and suitable for machine washing.

Extras on the hotel-max. service basket:

Two basket heights are available, each equipped with a basket for small items. Additionally, the lower version* has one compartment divider.

* Height 440 mm

01.04 hotel-max

■ Elegant and manoeuvrable multi-function trolleys from Wanzl.

The hotel-max does its job as a constant, "invisible" companion to the housekeeping teams, while maintaining the exclusive ambience of the hotel.

Collapsible to save storage space

The hotel-max service trolleys can be folded down to occupy very little space when they are not needed. It really doesn't get any more practical. Both very quickly become indispensable.



HOTEL-MAX

A lot of space for cleaning equipment

Everything you need for housekeeping can be comfortably accommodated in the wire basket on the steering handle of the hotel-max.



Particularly gentle

Plastic profiles ensure additional protection on all surfaces. The double edging wire provides additional support for the service basket.

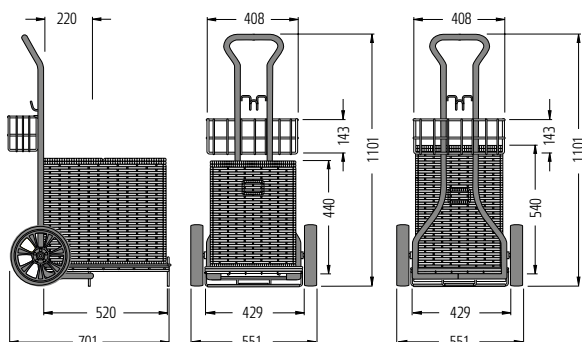

hotel-max L		Order no.
hotel-max service trolley* W 551 x D 701 x H 1101 mm		04.73112.96-0001
Service basket for hotel-max with small items basket and compartment dividers W 390 x D 520 x H 440 mm	Black	05.47348.07-0001
Service basket for hotel-max with small items basket, without compartment dividers W 390 x D 520 x H 540 mm	Black	05.53563.07-9005

* Pat. pend.

01.05 SW 80 handcart

Sorting laundry made easy

- > Up to three modules with bags in 4 different colours
- > Pre-sorting to save mix-ups
- > Robust rubber rings for securing bags



SW 3/80

Fabric bags in blue, red and apricot

01.05 SW 80 handcart

■ **Laundry pre-sorting** in the versions with 2 or 3 modules thanks to different coloured bags. These nifty trolleys make sure that all dirty laundry is correctly sorted for washing.

80 kg ↓



SW 1/80
Fabric bag in mint

80 kg ↓



SW 1/80
Polyester bag

160 kg ↓



SW 2/80
Fabric bags in red and blue

Securely fastened

Robust rubber rings provide simple and secure fastening of the bags.

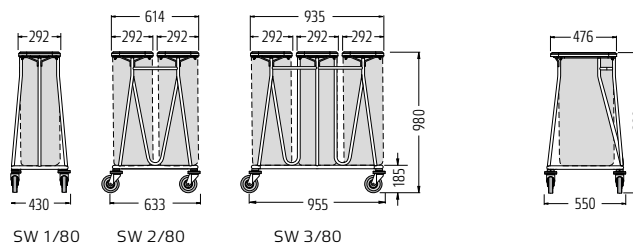

Standard equipment: Sturdy steel-tube design. Chassis with welded wire rack as support for enhanced stability. Plastic lid with handy recessed handle. Bag secured with flexible rubber rings to prevent slipping.

Surface finish: Plastic-powder coating in titanium grey.

Castors: 4 swivel castors, with plastic deflector rings and rubber treads, castor diameter 125 mm.

SW 80 handcart	Order no.
SW 1/80, for hanging 1 bag (bag not included)	04.08928.75-7097
SW 2/80 for hanging 2 bags (bags not included)	04.09041.75-7097
SW 3/80 for hanging 3 bags (bags not included)	04.09154.75-7097
Accessories (bags for initial and repeat orders)	
1 fabric bag, 80 litres, red	00.70540.00-0000
1 fabric bag, 80 litres, blue	00.60935.00-0000
1 fabric bag, 80 litres, apricot	00.61613.00-0000
1 fabric bag, 80 litres, mint	00.59692.00-0000
1 polyester bag, 80 litres	77.69618.00-0000

01.06 SW KX handcart

The agile model for hotels of every size

- > Smart folding mechanism for space-saving storage
- > Flexible configuration with 2 bag variants
- > Sturdy steel tube design with wire rack attached as support surface



01.06 SW KX handcart

■ A flexible laundry trolley for all situations.

The practical handcart, including a sturdy polyester bag, can be ordered in two sizes to suit individual requirements. The SW 145 KX can also be equipped with a plastic bag to transport rubbish.



SW 145 KX

Can be folded to save space

SW 290 KX

Can be folded to save space



It couldn't be easier

The non-wearing hook-and-loop fastener provides an easy way to secure the polyester bag in position.

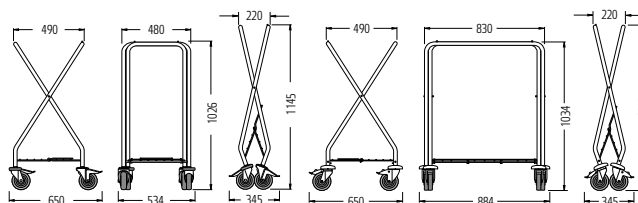

Standard equipment: Sturdy steel tube design with wire rack attached as support surface. Hook-and-loop fastener for polyester bag, flat steel retainer bar for plastic bag.

Surface finish: Plastic powder-coated in metallic black.

Castors: 4 swivel castors with plastic deflector rings, 2 of which have brakes and rubber tread, castor diameter 125 mm.

SW 145 KX handcart	Order no.
Basic frame with polyester bag and hook-and-loop fastener	04.03843.95--7097
Basic frame with plastic bag and holder	04.03618.95--7097
Accessories	
Holder for plastic bag, incl. fixings	04.03956.52-0000
Bags for repeat order	
1 polyester bag, 145 litres	77.94057.00-0000
1 pack of plastic bags, 120 litres, grey (1 pack = 25 units)	00.24436.00-0000
SW 290 KX handcart	Order no.
Basic frame with polyester bag and hook-and-loop fastener	04.15934.95-7097
Accessories	
Bags for repeat order	
1 polyester bag, 290 litres	77.95527.00-0000

01.07 LT 240 handcart

XXL laundry service

- > Extra-large laundry bag, 240 l
- > Integrated deflectors with 140 mm diameter to protect interiors
- > High load capacity, stable and durable



LT 240
handcart

Practical hook-and-loop fastener

It couldn't be easier: the non-wearing hook-and-loop fastener easily secures the polyester bag in position.

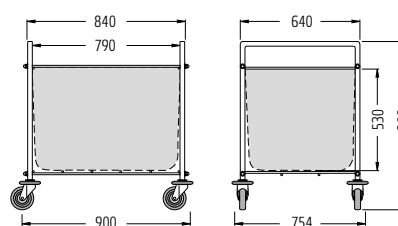

Standard equipment: Steel-tube design with sturdy wire rack as support surface. Practical all-round hook-and-loop fastener for securing the large polyester bag, optionally with cover.

Surface finish: Plastic powder-coated in metallic black
Castors: 4 swivel castors, diameter 125 mm, with rubber tread, plastic deflector rings.

LT 240 handcart	Order no.
With 1 polyester bag as standard	04.13900.95-7097
Unassembled for self-assembly With 1 polyester bag as standard	04.13900.95-0001
For repeat orders	
Polyester bag, grey, 240 litres	00.58562.00-0000
Polyester bag, grey, 240 litres, with cover	00.58563.00-0000

01.08 KS 600 luggage stand

Space for all the luggage

- > *An indispensable feature of every guest room*
- > *Rear bar to prevent slipping*
- > *Folding mechanism for space-saving storage*



KS 600
Luggage stand, folded



KS 600
High-gloss chrome-plated

Protects the interiors of your hotel

The **high bar** and the extension of the rear feet ensure the necessary distance is kept from the wall to avoid damage.

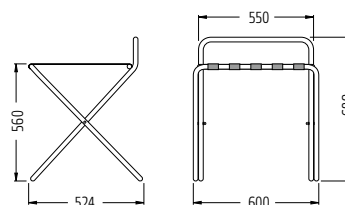

Standard equipment: Easy-to-handle tube frame with bar at back to prevent slipping. Folding mechanism for space-saving storage. Heavy-duty black belts prevent damage to cases.

Surfaces: high-gloss chrome-plated.

KS 600 luggage stand

KS 600 high-gloss, chrome-plated

Order no.

04.01922.10-0000

01.09 RCW room change trolley

A professional solution for room changes

- > *Quick and easy*
- > *With clothes rail and 2 wire shelves as standard*
- > *Matching clothes hangers optional*



RCW
Room change trolley

Variable installation of the shelves

With plastic clamping bushes at 50 mm intervals, the shelves can be flexibly adjusted to the desired height.

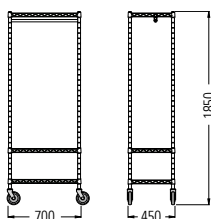
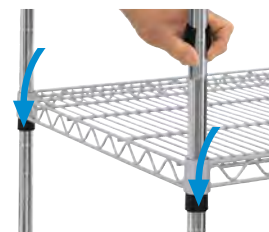

Attachable coat rail

For protecting items during transport: Provides a professional way for guests to change rooms or living quarters quickly and easily.



Standard equipment: Uprights with end caps. Plastic clamping bushes for mounting the wire shelves at 50 mm intervals. Wire shelves with plastic-powder coating, white, wheel castor diameter 125 mm.

Mobile

With high quality swivel castors, 2 with brakes – guarantee stability and mobility as required. Castor diameter 125 mm.



RCW room change trolley

With clothes rail and 3 wire shelves

Order no.

04.30011.10-0000

01.10 GR clothes stands

A pared-down form with unsurpassed functioning

- > *Can be nested to save space*
- > *Easy to move on castors, brakes optionally available*
- > *With practical hat rack*



GR
Clothes stands,
can be nested

GR
Clothes stands,
illustration shows optional accessories

Right at the top

Practical hat rack: neatly stowed away but quickly ready to hand again.

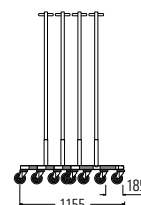
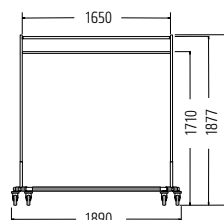

Standard equipment: Elegant steel-tube design with coat rail and practical hat rack. Conical chassis, can be nested to save space.

Surface finish: Chassis with plastic-powder coating in titanium grey, other parts high-gloss chrome-plated.

Castors: 4 swivel castors with rubber tread, supplied with plastic deflector rings as standard, castor diameter 125 mm.

GR Clothes stands	Order no.
With hat rack	04.02713.95-7084
With hat rack and 2 brakes	04.02713.95-0001

01.11 X-Bed additional bed

An extra bed for use anywhere

- > *Sturdy metal bed*
- > *Fast-folding frame*
- > *Mobile thanks to four swivel castors*



X-BED
Illustration shows optional
equipment



X-BED
Secured with the belt,
the X-Bed can be
stored safely to save
space, or moved.

01.11 X-Bed additional bed

■ **The X-Bed is pleasant to lie on** with a seat height of approx. 55 cm. The wire mesh allows for perfect ventilation of the mattress.



X-BED

Figure shows the delivery scope



Automatic folding mechanism with lock

Easy and quick to set up thanks to the handy automatic folding mechanism with lock.



Standard equipment: Sturdy, high-quality square metal frame, wire rack, automatic folding mechanism with lock, max. load-bearing capacity is 120 kg, weighs 23 kg.

Surface finish: Plastic-powder coated in metallic black

Castors: 4 swivel castors, incl. 2 with brakes, castor diameter 125 mm.

Accessories: Foldable mattress made of highly stable polyether foam, suitable for hotel use (can be sterilised). Durable anthracite-coloured cover with quilted surface, removable and washable.

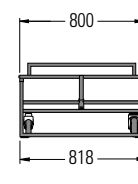
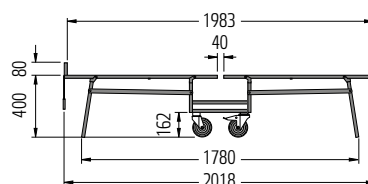
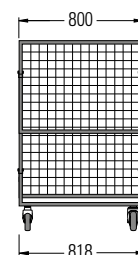
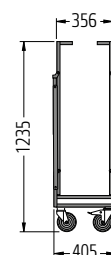

X-Bed	Order no.
Plastic-powder coating, black metallic incl. mattress	04.16047.95-7097
Accessories	
Polyether foam mattress, 80 x 200 x 15 cm	04.15482.07-0000

01.12 AL sprung-base trolley

A laundry trolley for smooth service

- > Robust trolley made from aluminium
- > With automatic height adjustment of the base shelf thanks to a sturdy steel spring
- > Can be used universally



AL SPRUNG-BASE TROLLEY

Perfect position

A sturdy steel spring ensures that the base shelf is always at the ideal height, irrespective of the load.

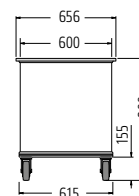
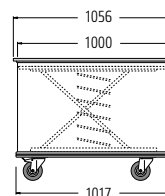

Standard equipment: Robust trolley made of anodised aluminium. The base shelf is raised and lowered automatically depending on the weight of the transported goods. This enables staff to load and unload the trolley comfortably and without straining their backs.

Castors: 4 swivel castors, incl. 2 with brakes, castor diameter 125 mm.

AL sprung-base trolley

With adjustable base shelf

Order no.

04.06216.45-0000

01.13 AL shelved laundry container

A mobile container for transporting laundry

- > *Fold-out container shelves enable easy handling*
- > *All-round plastic bumper profile*
- > *Plastic roll-down front panel as standard*



100 kg

AL SHELVED LAUNDRY CONTAINER



Transporting clean linen

With roll-down front panel

Mobile container

For transporting large volumes of dirty and clean laundry, which saves staff unnecessary journeys. The fold-out container shelves can be easily handled, transforming the AL shelved laundry container into a trolley for collecting used laundry in next to no time.

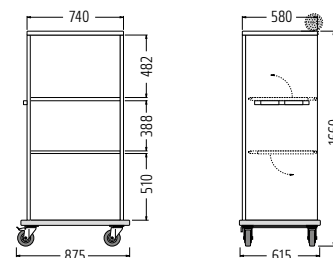

Standard equipment: Sturdy construction made of anodised aluminium. All-round plastic bumper. Roll-down front panel made of plastic as standard. Two 90° hinged shelves.

Horizontal position: For clean laundry.

Vertical position: For dirty laundry.

Castors: 4 swivel castors, incl. 2 with brakes, castor diameter 125 mm.

AL shelved laundry container

Including Roll-down front panel

Order no.

04.05877.45-0000

01.14 KT3 shelved laundry trolley

Transport trolley for clean laundry

- > Adjustable shelves for easy handling
- > Agile and easy to manoeuvre thanks to the 5th castor
- > Two pushing handles



KT3 SHELVED LAUNDRY TROLLEY
Illustration shows optional equipment

Pushing handles fitted as standard

Simple and comfortable operation in confined spaces thanks to the two pushing handles.



Deflectors

Non-marking deflectors on the frame protect your interior décor from damage.



5th castor Simply ingenious:

The **5th castor** allows the trolley to turn on the spot.

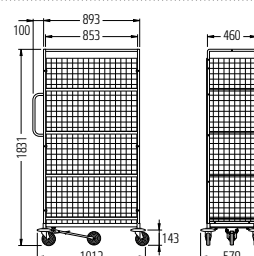

Standard equipment: Chassis made from square tubing. Side panels made up of square tubing frame with wire rack inserted into chassis and screwed into place. 4 adjustable shelves. 4 large deflectors to protect the furniture.

Surface finish: High-gloss, galvanised, chrome-plated.

Castors: 4 swivel castors, fifth castor, diameter 125 mm, fitted in the centre for easy manoeuvrability. The shelved laundry trolley can turn on the spot.

KT3 shelved laundry trolley

High-gloss galvanised, chrome-plated

Order no.

06.00231.50-V310

01.15 TK-R, TK-D transport baskets

Mobile transport baskets, either open or with a lid

> Close-meshed wire baskets

> Two versions

> TK-R with bumper, TK-D with lid



TK-R
Transport basket



TK-D
Transport basket



Both transport baskets can be stacked to save space.

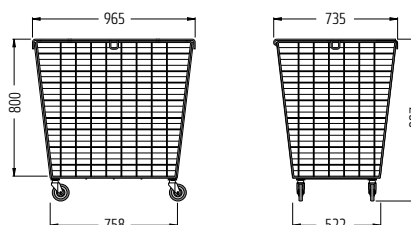
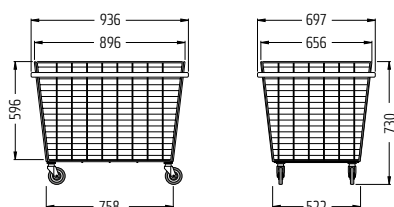

Standard equipment: Close-meshed wire basket with white all-round rubber profile as bumper.

Surface finish: Plastic-powder coating, white.

Castors: 4 swivel castors, with plastic deflector rings and rubber treads, castor diameter 125 mm.

Standard equipment: Tall, close-meshed wire basket with lid, can be locked if required. Padlock not included in delivery scope.

Surface finish: High-gloss galvanised, chrome-plated, silver.

Castors: 4 swivel castors, rubber tread, castor diameter 100 mm.

TK-R transport basket	Order no.
With bumper	05.42710.61-9010

TK-D transport basket	Order no.
With lid	05.41810.50-0000

01.16 RC/N1 roll cage

Lightweight design

- > *Can be nested to save space*
- > *Locking mechanism suitable for padlock*
- > *Hinged support surface*



RC/N1
Basic model with additional wire shelf (accessory)



Can be nested to save space

Space requirement in row
Per roll cage 200 mm
10 mobile containers 2,655 mm
50 mobile containers 10,655 mm

Locking mechanism

The locking mechanism can be secured with a padlock if required.

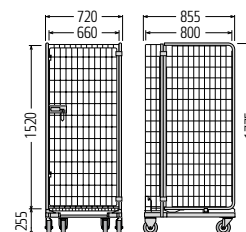

Standard equipment: Square tube frame chassis, welded. Hinged support surface made of wire mesh. Container structure of round-tube frame with wire mesh and plastic hinges. Door opening angle 270°.

Surface finish: High-gloss, galvanised, chrome-plated.

Castors: 2 fixed castors, 2 swivel polyamide castors, castor wheel diameter 125 mm.

RC/N1 roll cage	Order no.
Nesting	06.16386.50-V001
Accessories	
Wire shelf	00.97494.50-0000

01.17 RC/N2 roll cage

Nesting container variant

- > Effortless collapsing and nesting facilitates storage
- > 2-part door, opened separately
- > Wire shelf and clothes rail as standard

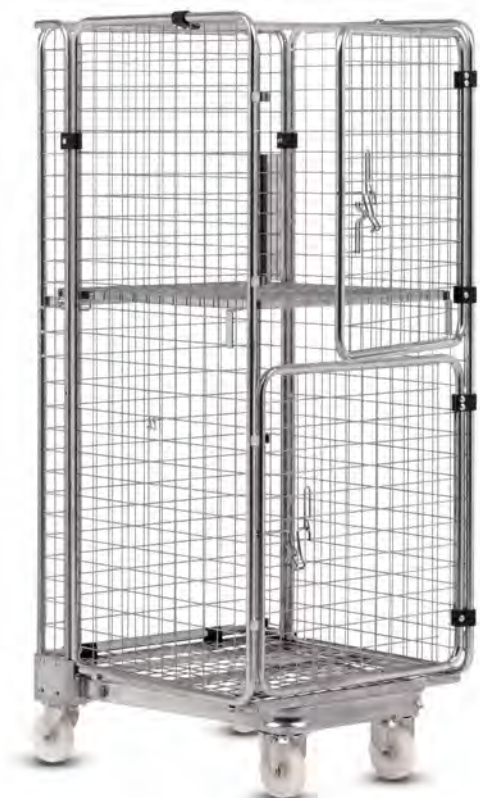

RC/N2
Basic model with hinged wire shelf (standard)



Can be nested to save space

Space requirement in row	
Per roll cage	200 mm
10 mobile containers	2,655 mm
50 mobile containers	10,655 mm

Clothes rail

Hinged.
Made of round tube with plastic hinge.



Plate

Made of metal. For stickers, labelling, etc.
Size 114 x 323 mm

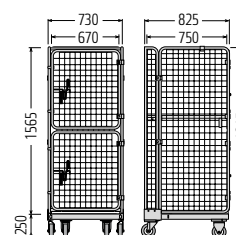
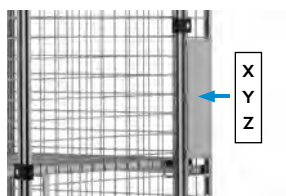

Standard equipment: Square tube frame chassis, curved. Hinged support surface made of square tube frame with wire mesh, reinforced with flat steel strips. Container structure of round-tube frame with wire mesh and plastic hinges. 2-part door with opening angle 270°.

Surface finish: High-gloss, galvanised, chrome-plated.

Castors: 2 fixed castors, 2 swivel polyamide castors, castor wheel diameter 125 mm.

RC/N2 roll cage

Can be nested,
with wire shelf and clothes rail as standard

Order no.

06.17515.50-V001

02 Front Office



02 Front Office



A good impression thanks to luggage trolley

■ **With its reception, the front office** is the first point of contact for guests in a hotel. This is where the guest's first impression is made, and it is therefore particularly important to impress here.

Wanzl offers a wide range of high-quality luggage trolleys for transporting luggage. Our entire luggage collection trolley range is tastefully designed and visually enhances your front office. A special service for your guests are our elegant luggage transport trolleys, which can also be nested to save space when not in use.

02.01 Premium GS-Trend

The extravagant luggage collection trolley

- > *An eye-catcher at check-in*
- > *Highly manoeuvrable, optional with locking brake*
- > *Integrated coat rail*



GS-TREND

Electro-polished stainless steel
Illustration shows optional equipment.

Design pend.

02.01 Premium GS-Trend

■ **Elegant and stylish first impression.** Innovation and quality packaged in an elegant design: the GS-Trend.



GS-TREND
Plastic-powder coated, black
Illustration shows optional equipment.



Carpet finishes



Design pend.

Optional locking brake

Securely positioned:

Even when the GS-Trend is loaded with lots of luggage, the brake holds it in place on uneven flooring.

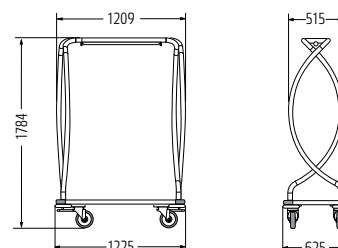

Standard equipment: Round-tube design with coat rail. Sturdy platform with all round bumper and deflectors, heavy-duty, stain resistant grey melange carpet.

Surface finish: Stainless steel, electro-polished or plastic-powder coated in metallic black.

Castors: 2 swivel castors, 2 fixed castors, quiet rubber tread, castor diameter 160 mm.

GS-Trend luggage collection trolley	Order no.
Stainless steel, electro-polished, grey melange carpet	05.59778.31-V006
Stainless steel, electro-polished, grey melange carpet, with locking brake	05.59778.31-V007
Stainless steel, plastic powder-coated black metallic, grey melange carpet, with locking brake	05.59778.37-V001
Logo carpet (from 3 units)	On request

02.02 GS-Lobby

The classic luggage collection trolley

- > Available in high-quality finishes
- > Attractive, durable carpet lining
- > Optional locking brake



GS-LOBBY
Stainless steel, gold-plated



GS-LOBBY
Stainless steel, black



GS-LOBBY
Stainless steel, electro-polished, with locking brake

Carpet finishes



Prevents the trolley accidentally rolling away

Optional locking brake

An ideal addition to make the GS-Lobby secure on inclines.

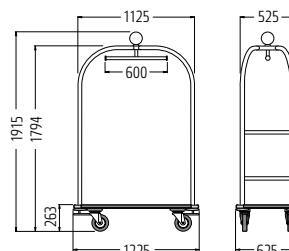

Standard equipment: Round-tube design with elegant 'crown' and coat rail. Sturdy platform with all-round bumper protection and deflectors, heavy duty, stain resistant carpet in anthracite.

Surface finish: Electro-polished stainless steel.

Castors: Wanzl bonded-on castors, castor diameter 160 mm, rubber tread. 2 fixed castors/2 swivel castors as standard.

GS-Lobby luggage collection trolley	Order no.
Stainless steel, electro-polished, grey melange carpet	04.14691.31-0000
Gold-plated stainless steel, carpet in red	04.14691.58-0001
Stainless steel, electro-polished, grey melange carpet, with locking brake	04.14691.31-0001
Gold-plated stainless steel, carpet in red, with locking brake	04.14691.58-0000
Stainless steel, metallic black, grey melange carpet, with locking brake	04.14691.37-0000
Logo carpet (from 3 units)	On request

02.03 GS-Group

The luggage collection trolley for group luggage

- > With generous, stable luggage storage
- > Plastic profiles on the sides to protect the interiors
- > Coat rail as standard, can be removed as required

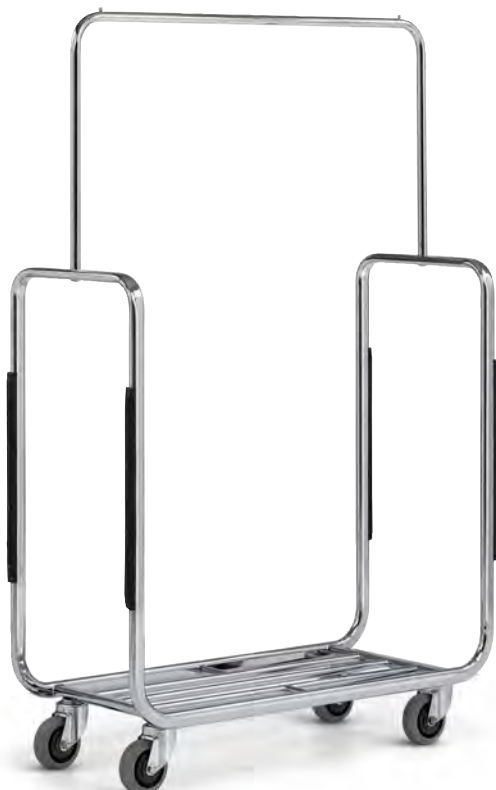

GS-GROUP
Luggage collection trolleys



GS-GROUP
Luggage collection trolley, with optional wooden platform

Coat rail as standard

Can be removed if necessary: a thoroughly practical detail, it can be flexibly adjusted to match the type and amount of luggage.

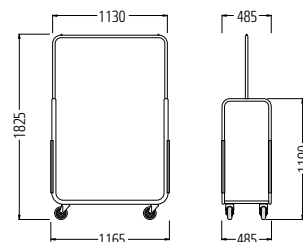

Standard equipment: Round-tube design with robust loading area for luggage. Plastic profiles mounted at the side on the upright struts to protect the interior décor.

Surface finish: Steel, high-gloss chrome-plated

Castors: 2 swivel castors, 2 fixed castors with quiet rubber tread, castor wheel diameter 125 mm.

GS-Group luggage collection trolley	Order no.
High-gloss chrome-plated	04.02148.10-0000
Accessories	
Wooden platform	77.39221.95-0000

02.04 GS-Compact

The practical luggage collection trolley

- > *Particularly ergonomic operation*
- > *Available with a choice of short or long loading area*
- > *Large pneumatic tyres for smooth running*



Folded flat to save space

Stable even when fully loaded

As practical as it gets.

Provides and saves lots of space with its fold-out loading area in two lengths.

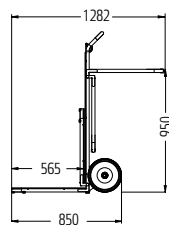

GS-Compact 600 A

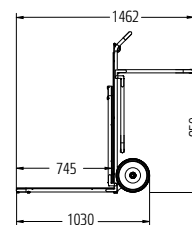

GS-Compact 800 R

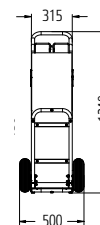

Standard equipment: Round-tube design. Platform can be unfolded for use and folded back up if necessary for space-saving storage. Loading area covered with tough, non-slip carpet.

Surface finish: Stainless steel, gold-plated stainless steel.

Castors: Two pneumatic tyres for smooth running, black tread, pneumatic tyre diameter: 260 mm.

GS-Compact luggage collection trolley	Order no.
GS-Compact 600 R, stainless steel, carpet in red	05.26782.31-V003
GS-Compact 600 A, stainless steel, carpet in anthracite	05.26782.31-V002
GS-Compact 800 R, stainless steel, carpet in red	05.23731.31-V003
GS-Compact 800 A, stainless steel, carpet in anthracite	05.23731.31-V002
GS-Compact 600 R, gold-plated stainless steel, carpet in red	05.26782.58-V001
GS-Compact 800 R, gold-plated stainless steel, carpet in red	05.23731.58-V001

02.05 Aera 300 L

The stylish luggage transport trolley

- > *Impressively slim design*
- > *Large deflectors protect luggage – the all-round bumper rail protects interiors*
- > *Large, high-quality castors guarantee easy handling*



Design pend.

AERA 300 L
Luggage transport trolleys

Large, protective deflectors

Luggage stays undamaged.

A useful detail that adds to the appeal of the Aera 300 L.

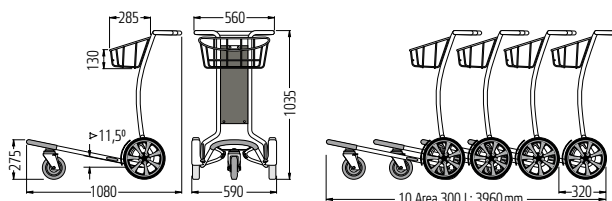

■ Advertising space

Can be nested to save space

Standard equipment: Steel, round-tube design. All-round bumper rail on the large loading area. Generous powder-coated basket. Can be nested to save space.

Surface finish: Galvanised, chrome-plated, transparent, polyester-coated.

Castors: 2 fixed castors, 1 swivel castor, fixed castor diameter 280 mm, swivel castor diameter 160 mm.



Special feature included as extra: The handle of the Aera 300 L is treated with an antibacterial coating, ensuring hygienic conditions in the hotel environment.

Aera 300 L luggage transport trolley	Order no.
Galvanised chrome-plated	05.60795.52-0000

02.06 Travel 300

Luggage transport trolley – simple and convenient

- > *Antibacterial, ergonomic handle with side caps*
- > *Can be nested to save space*
- > *Plastic profiles prevent damage to interiors*



TRAVEL 300
Luggage transport trolleys

Pat. pend.

A stylish space-saver

Wanzl luggage transport trolleys are stylish space-savers for use anywhere. Very versatile and capable of very compact nesting, they allow even large numbers to be used in hotels of all kinds – a benefit that your guests will appreciate too.

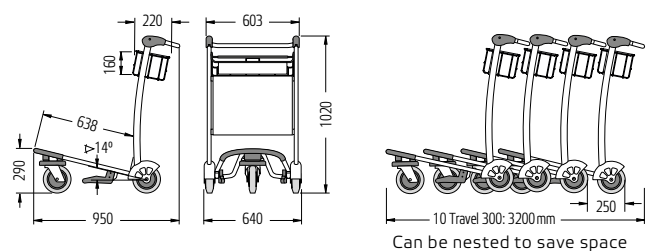

Standard equipment: Steel-tube design with sturdy luggage loading area. Self-adjusting, zero-maintenance brake. All-round bumper rail on the loading area. Practical basket for hand luggage or travel paraphernalia. Can be nested to save space.

Surface finish: Galvanised, chrome-plated, transparent, polyester-coated.

Castors: 2 fixed castors, 1 swivel castor, rubber tread, castor diameter 180 mm.



Special feature included as extra:

The handle of the Travel 300 is treated with an antibacterial coating, ensuring hygienic conditions in the hotel environment.

Travel 300 luggage transport trolley

Galvanised chrome-plated steel, with brake

Order no.

05.85429.52-0003

02.07 Part Flex 2000

Flexible guidance system

- > A mobile and effective way to section off areas
- > Uprights made of steel tubing with integrated reel mechanism for pull-out bands
- > Triple docking facility



PART FLEX 2000
Guidance system

WALL CLIP
made of stainless steel

Barriers in up to 4 directions

Very flexible and effective guidance system, can be used to separate areas and direct people.



Printed pull-out band

Your hotel logo can be printed as you wish. Fully in keeping with your universal corporate design.



On request.

Standard equipment: Uprights made from steel tubing with integrated reel mechanism and triple docking facility. Pull-out bands in 3 colours, 2,000 mm long. Base plate with slip-proof plastic profile, cover made from black plastic.

Surface finish: Uprights with high-gloss chrome plated

Dimensions: Upright height 940 mm, base plate diameter 340 mm.

Part Flex 2000	Order no.
Upright with pull-out band, red	23.75100.10-0000
Upright with pull-out band, dark blue	23.75101.10-0000
Upright with pull-out band, grey	23.75102.10-0000
Accessories	
Wall clip	23.92892.09-0000

02.08 Part Line 2000

One of the finest examples of guidance systems

- > *Sleek elegance for every occasion*
- > *Subtle separation of lobbies, foyers and meeting rooms*
- > *With practical accessories: Poster holder*



MODEL L
In chrome and brass

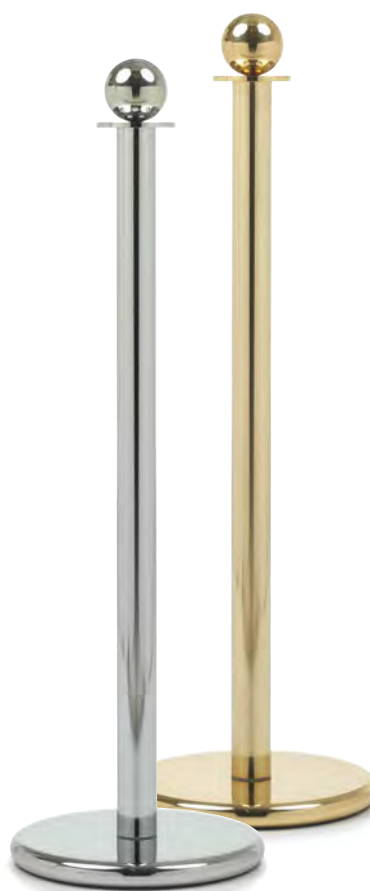

















MODEL C
in chrome and brass

PART LINE 2000
Guidance system

02.08 Part Line 2000

**MODEL L**

In chrome with poster holder
Red twisted polypropylene rope

Part Line 2000		Supplied unassembled	Order no.	Order no.
Uprights			Chrome finish	Brass finish
		Model L With cone-shaped head, height 950 mm, base plate diameter 320 mm	04.07122.10-0001	04.07128.06-0000
		Model C With round head, height 1,010 mm, base plate diameter 320 mm	04.07120.10-0001	04.07127.06-0000
Wall fastening			Chrome finish	Brass finish
		Wall fastening	04.07233.10-0000	04.07233.06-0000
Rope – velvet, 2 m			Chrome finish	Brass finish
End pieces	Rope colour			
		Red	77.38646.00-0001	77.38647.00-0001
		Black	77.38646.00-0002	77.38647.00-0002
Rope – twisted polypropylene, 2 m				
End pieces	Rope colour			
		Red	77.38645.00-0001	77.38648.00-0001
		Black	77.38645.00-0002	77.38648.00-0002
Accessories			Chrome finish	Brass finish
Poster holder for uprights (model L)				
		DIN A4 portrait	04.07124.00-0000	04.07126.00-0000
		DIN A4 landscape	04.07125.00-0000	04.07131.00-0000
Head for poster holder			✓	✓

03 Food + Beverage



03 Food + Beverage



Flexible guest catering

■ **As already described in the name itself**, the F&B sector is all about food and beverages. This sector includes the bar and restaurant, banquets and the floor service including minibars.

Our F&B range includes various minibar filling trolleys as well as serving and bottle trolleys. Wanzl offers smart and secure minibar filling trolleys for efficient floor service. The Comfort room service table ensures that your guests can have an exclusive dinner in their own room. Our mobile coffee station is ideal for events and conferences.

03.01 MBW Smart

Minibar filling trolley – with 2 levels

- > Lockable roll-down panel
- > Insertable shelves with wire bar – railing to prevent slipping
- > With deflectors to protect the interiors



Design pend.

Finishes



MBW SMART
Natural oak finish

03.01 MBW Smart minibar filling trolley

■ **A reliable partner for the minibar service** with clearly structured divisions for efficient filling of bottles and small items.

Security as standard

Locking roll-down front panel for all MBW Smart models.



Protective feature

Integrated deflectors made of rubber and an all-round bumper profile protect the interior décor of your hotel.



Standard equipment: Steel-tube design, 2 fixed and 2 height-adjustable levels. Chassis with all-round bumper profile and integrated rubber deflectors. Front side with lockable roll-down panel.

Surface finish: Plastic-powder coating in titanium grey.

MBW Smart-7 castors: 2 swivel castors, 2 fixed castors with polyamide tread, castor diameter 200 mm.

MBW Smart-9/-11: 2 swivel castors, 2 fixed castors with polyamide tread, castor diameter 200 mm.

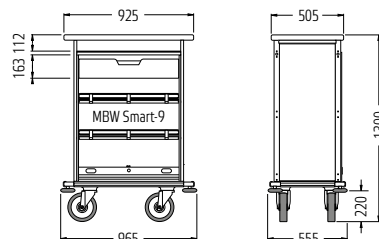

Other sizes for MBW Smart as on page 5.

Minibar filling trolley models		MBW Smart-7	MBW Smart-9	MBW Smart-11
Dimensions		805 x 555 x 1,300	965 x 555 x 1,300	1,155 x 555 x 1,300
		Order no.	Order no.	Order no.
MBW Smart	anthracite, natural oak, mahogany finish	04.01250.95-V	04.01251.95-V	04.01252.95-V

Optional equipment				
Drawer made from sheet steel, with plastic-powder coating, titanium grey		☑	☑	☑
Shortened shelf, with wire bar to prevent slipping	anthracite, natural oak, mahogany finish	☑	☑	☑
Closable lid	anthracite, natural oak, mahogany finish	☑	☑	☑
Castors with rubber tread		☑	☑	☑
Accessories				
Wooden box for small items, painted light pearl grey		00.21837.78-9022	00.21837.78-9022	00.21837.78-9022
Wooden box for small items, clear varnished		00.60694.78-0000	00.60694.78-0000	00.60694.78-0000
Brochure holder, metal, titanium grey		00.22289.73-7084	00.22289.73-7084	00.22289.73-7084
Top box, metal, plastic-powder coated in titanium grey		04.03504.73-7084	04.03504.73-7084	04.03504.73-7084
Spaces for top box on top shelf		1	1	2
Drawer dividers		77.76090.73-7084	77.76090.73-7084	77.76090.73-7084

03.02 MBW Secure

Minibar filling trolley – with 3 drawers

- > With lockable plastic roll-down panel as standard
- > Practical dividers to improve organisation
- > Transports bottles upright up to a height of 31 cm



Design pend.

Finishes



MBW SECURE
Anthracite finish

03.02 MBW Secure minibar filling trolley

■ **For a reliable minibar service.** Improved design incorporating new drawer division, optimised recessed handles and an effective bumper.



MBW SECURE
Anthracite finish

Upright transportation of bottles

A highlight for the minibar service is the upright transportation of 0.7-litre bottles.



Practical dividers

Better organisation for filling minibars and bottles prevented from falling over during transport.



Standard equipment: Steel-tube design, 3 stable drawers, each with 2 dividers, can be pulled out individually, with built-in lock. Chassis with all-round bumper profile and integrated (non-marking) rubber deflectors. Front side with lockable roll-down panel.

Surface finish: Plastic-powder coating in titanium grey.

MBW Secure-7 castors: 2 swivel castors, 2 fixed castors with polyamide tread, castor diameter 200 mm.

MBW Secure-9/-11: 2 swivel castors, 2 fixed castors with polyamide tread, castor diameter 200 mm.

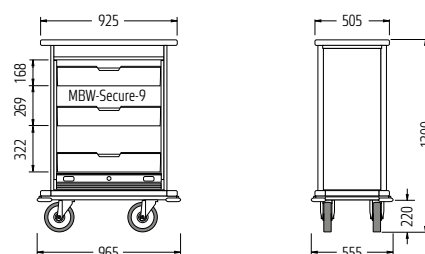

Other sizes for MBW Smart as on page 5.

Minibar filling trolley models		MBW Secure-7	MBW Secure-9	MBW Secure-11
Dimensions		805 x 555 x 1,300	965 x 555 x 1,300	1,155 x 555 x 1,300
		Order no.	Order no.	Order no.
MBW Secure	anthracite, natural oak, mahogany finish	04.03140.95-V	04.03150.95-V	04.03160.95-V

Optional equipment				
Closable lid	anthracite, natural oak, mahogany finish	<input checked="" type="checkbox"/>	<input checked="" type="checkbox"/>	<input checked="" type="checkbox"/>
Castors with rubber tread		<input checked="" type="checkbox"/>	<input checked="" type="checkbox"/>	<input checked="" type="checkbox"/>
Accessories				
Wooden box for small items, painted light pearl grey		00.21837.78-9022	00.21837.78-9022	00.21837.78-9022
Wooden box for small items, clear varnished		00.60694.78-0000	00.60694.78-0000	00.60694.78-0000
Brochure holder, metal, titanium grey		00.22289.73-7084	00.22289.73-7084	00.22289.73-7084
Top box, metal, plastic-powder coating in titanium grey		04.03504.73-7084	04.03504.73-7084	04.03504.73-7084
Spaces for top box on top shelf		1	1	2
Drawer dividers		77.76090.73-7084	77.76090.73-7084	77.76090.73-7084

03.03 Comfort room service table

Dine in your room!

- > *With hinged side panels*
- > *Can be nested to save space*
- > *Optional, integrating hot box*



ROOM SERVICE TABLE



The room service table can be folded together in just a few simple steps for transport in the elevator or for space-saving storage.

03.03 Comfort room service table

■ **Ideally dimensioned and stable side table** for hotel rooms and restaurants, folding sides for narrow passages. Also available on request with integrated hot box for keeping meals hot.

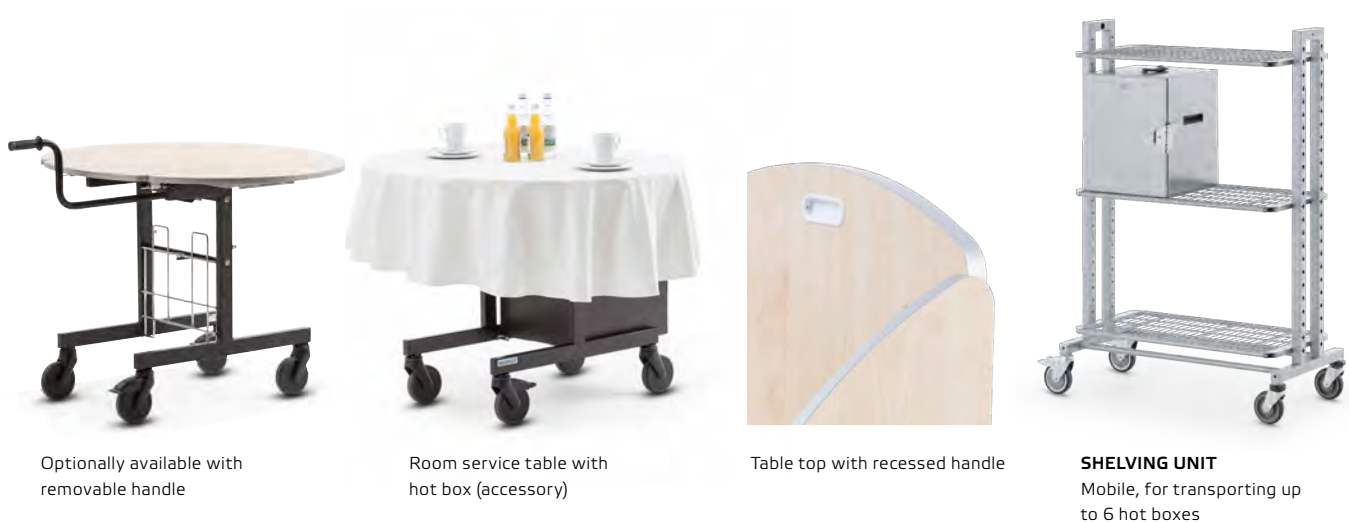

Optionally available with removable handle

Room service table with hot box (accessory)

Table top with recessed handle

SHELVING UNIT
Mobile, for transporting up to 6 hot boxes

Hot box

With 3 shelves, the hot box is ideal for ensuring meals stay hot on their way to guest rooms. All connections on the back.



HOT BOX
Stainless steel

HOT BOX
Black

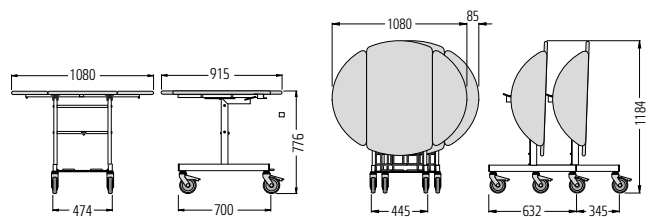

Can be nested to save space

Standard equipment: Steel-tube design with oval table top in wood finish with tough, sealed edge and fold-down side parts. Fold-out chrome-plated tray for the hot box. The table tops can be locked in a vertical position for storage and transport and the Comfort room-service table can be nested to save space.

Surface finish: Plastic-powder coated in jet black.

Castors: 4 swivel castors, incl. 2 with brakes, rubber tread, castor diameter 125 mm.

RSVC-Comfort room-service table	Order no.
With fold-down side sections and 2 wire racks	04.12883.95-0000
Accessories	
Removable push handle	04.12996.73-9005
Dimensions for 1 hot box (mm) W 410 x D 410 x H 530	
Electric hot box, with 3 shelves, stainless steel	77.91379.09-0000
Electric hot box, with 3 shelves, black	77.91379.09-0001
Shelf unit for 6 hot boxes, mobile	
Dimensions (mm) W 1050 x D 500 x H 1500	04.14804.73-7084

03.04 EG 300 serving trolley

The classic

- > With 3 shelves
- > High edges all around for safe transport
- > Hygienic, made from stainless steel

40 kg
↓
per shelf



EG 300
Serving trolley

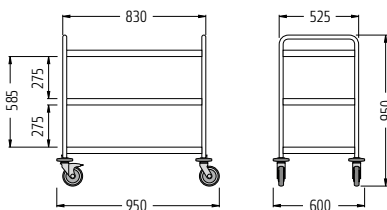

Standard equipment: Round-tube design, with 3 shelves made of stainless steel.

Finish: Round tube and shelves made from stainless steel.

Castors: 4 swivel castors with plastic deflector rings, 2 with brakes. Rubber tread, castor diameter 125 mm.

EG 300 serving trolley

EG 300 with 3 shelves

With optional ultra-smooth castors

Order no.

04.04400.09-0000

04.04400.09-0001

03.05 Bottle trolleys

Sturdy trolley in three sizes

- > Flexible shelves
- > Storage and transport of 6, 8 or 12 drinks crates
- > With 2 brakes as standard



BOTTLE TROLLEY 6
For 6 bottle crates



BOTTLE TROLLEY 8
For 8 bottle crates

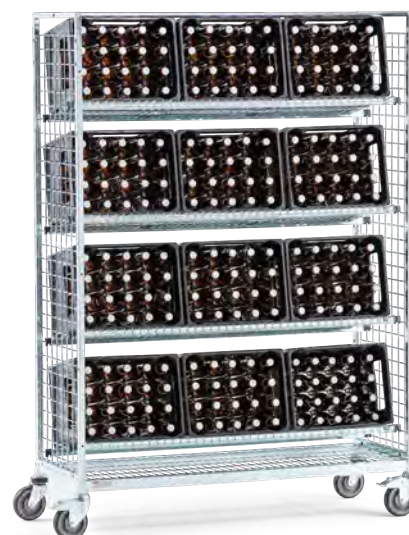

BOTTLE TROLLEY 12
For 12 bottle crates

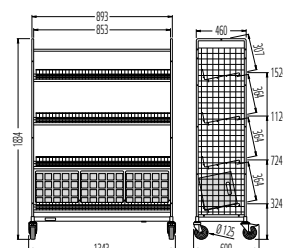
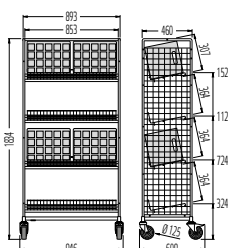
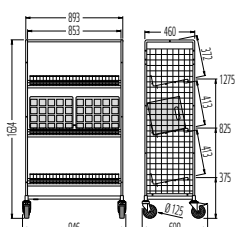
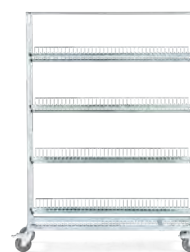

Mobile provision

The 2 brakes prevent unintended movement of the trolley, thus securing up to 12 drinks crates in position.



Surface: High-gloss galvanised, chrome-plated
Castors: 4 swivel castors with plastic deflector rings, 2 of which have brakes and rubber tread, castor diameter 125 mm.

Standard equipment: Chassis and side sections made from square tube frame with wire rack, adjustable shelves.

Bottle trolley	Order no.
Bottle trolley 6	05.82378.50-0000
Bottle trolley 8	05.82379.50-0000
Bottle trolley 12	05.82830.50-0000

04 Storage + Shelving



04 Storage + Shelving

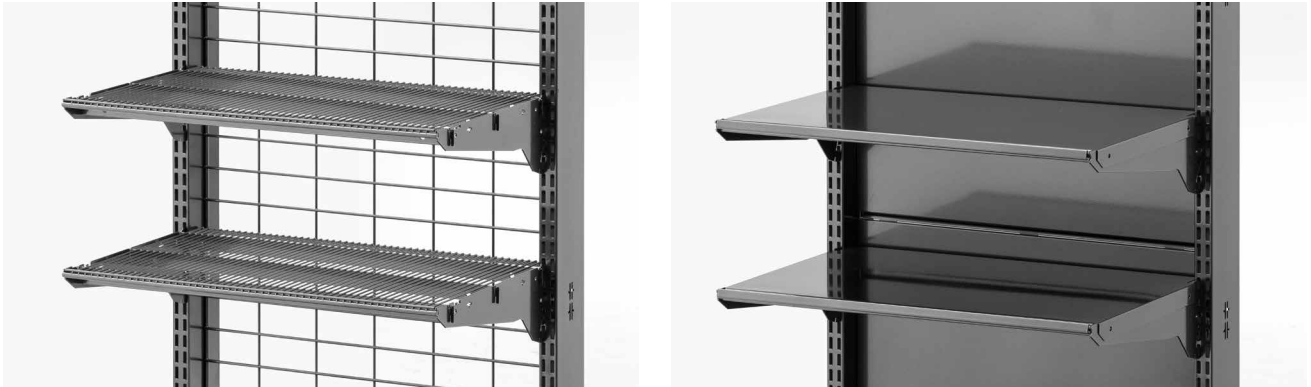

Efficient storage in the hotel

■ **Wanzl is known** for its high-quality and stable shelving systems. The hotel area in the back of house also benefits from this. Our high rack and wire tech 100 service shelves provide flexible storage space for various rooms in your hotel.

Wire tech 100 boasts easy installation and effective design. It visually enhances the rooms in your hotel and provides high-quality storage shelving with a high load capacity.

Our durable transport trolleys also help you transport your inventory.

04.01 wire tech 100

The trick with the click

- > Easy installation
- > Back panel made of wire mesh or sheet metal
- > Wire mesh or sheet metal shelves

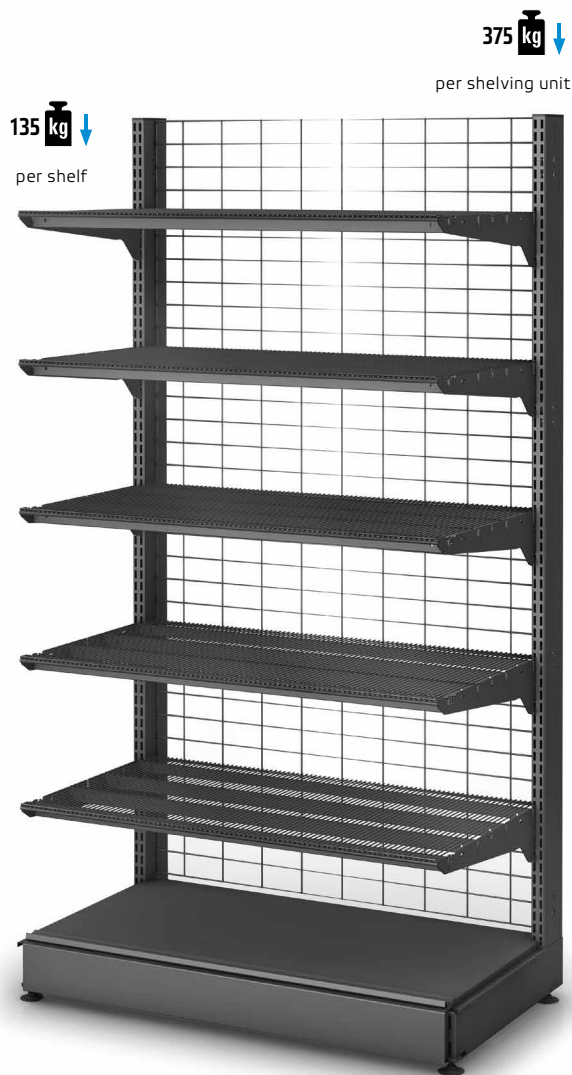

Back panels



Wire mesh



Sheet metal

Various widths

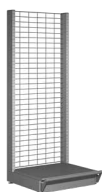

625 mm

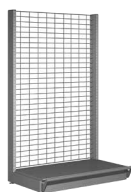

1,000 mm

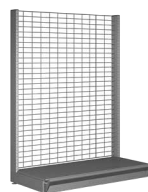

1,250 mm

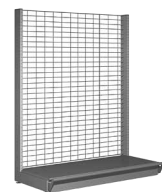

1,333 mm

04.01 wire tech 100

■ **The high-quality shelving system from Wanzl impresses** with its high flexibility and modular design. Benefit from proven Wanzl quality in your hotel, for example in the back offices or housekeeping and dry storage facilities. Decades of retail experience ensure reliability even in the toughest conditions.



Quick and easy “click” assembly

The **wire tech 100 click system** is designed to make the shelving units easy to assemble and quick to adapt to new requirements. Wanzl shelving systems offer smooth connections between components coupled with high shelf

stability. With just a few clicks, the console and wire shelf can be connected to each other and the consoles can be fixed to the uprights.



Effective combination of materials

Whether back panel, shelf or plinth elements: wire tech 100 adapts to your needs and the requirements of your store – not the other way around. The back panels made of wire, sheet metal or individually printed magnetic foil can be combined with wire or sheet metal shelves. The shelves can be attached at 25 mm intervals, allowing shelf heights to be adapted perfectly to the size of the products.

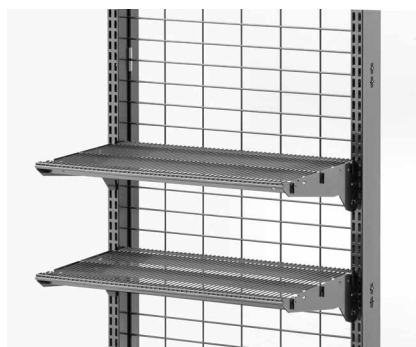

04.02 High rack

Fixed and mobile service shelf

- > Numerous base and extension elements
- > Shelves also available with plastic powder coating, white
- > Shelves are delivered unassembled – variable installation of the shelves



HIGH RACK
Fixed, corner combination
5 shelves, high-gloss chrome-plated (assembly example)



SHELF-CONNECTOR
Accessories

50 kg ↓
per shelf



HIGH RACK
Mobile, 4 shelves with
plastic-powder coating, white

HIGH RACK
Fixed, 5 shelves with
plastic-powder coating, white

04.02 High rack

■ **For even better organisation.** One of the most modern systems for organisation and transport, with numerous different base and expansion elements – fixed and mobile – as required.

Variable installation of the shelves

With plastic clamping bushes at 50 mm intervals, the shelves can be flexibly adjusted to the desired height.

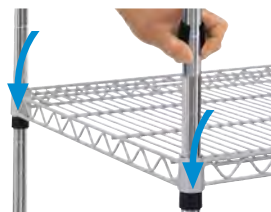

High rack, mobile

With high quality swivel castors, 2 with brakes – guarantee stability and mobility as required. Castor diameter 125 mm.



Standard equipment:

High-gloss, chrome-plated uprights with top end caps and plastic feet or 4 swivel castors, 2 with brakes, castor diameter 125 mm. Wire shelves in high-gloss chrome-plating or plastic-powder coating, white. Plastic clamping bushes for assembling wire shelves with a mesh width of 165 x 20 mm.

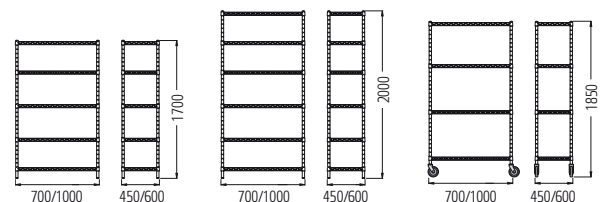

High rack, fixed		Order no.	Order no.
	Widths (mm)	Depth 450	Depth 600
Height 1,700 with 5 shelves			
Uprights and shelves:	700 mm	04.30001.10-0000	-
High-gloss chrome-plated	1,000 mm	04.30004.10-0000	04.30005.10-0000
Uprights: High-gloss chrome-plated	700 mm	04.30001.95-9010	-
Shelves: Plastic-powder coating, white	1,000 mm	04.30004.95-9010	04.30005.95-9010
Height 2,000 with 6 shelves			
Uprights and shelves:	700 mm	04.30006.10-0000	-
High-gloss chrome-plated	1,000 mm	04.30008.10-0000	04.30009.10-0000
Uprights: High-gloss chrome-plated	700 mm	04.30006.95-9010	-
Shelves: Plastic-powder coating, white	1,000 mm	04.30008.95-9010	04.30009.95-9010
Accessories			
Shelf connector		04.30020.00-0000	
High rack, mobile		Order no.	Order no.
	Widths (mm)	Depth 450	Depth 600
Height 1,850 with 4 shelves			
Uprights and shelves:	700 mm	04.03000.10-0000	-
High-gloss chrome-plated	1,000 mm	04.02826.10-0000	04.03010.10-0000
Uprights: High-gloss chrome-plated	700 mm	04.03000.95-9010	-
Shelves: Plastic-powder coating, white	1,000 mm	04.02826.95-9010	04.03010.95-9010

04.03 T25 transport trolley

Our little helper

- > Can be nested to save space
- > Wire platform with double edging wire
- > With close-meshed wire basket



T25
transport trolley

Can be nested to save space

Space requirement in row
per transporter 300 mm
10 transporters 3,770 mm

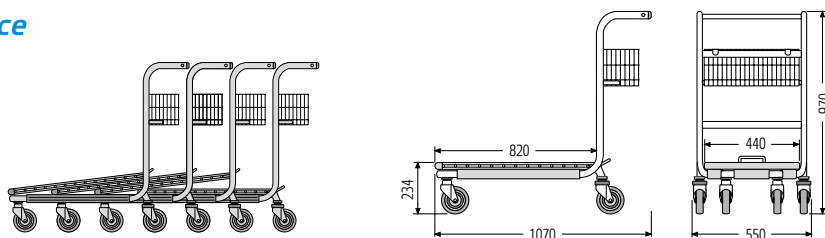

Standard equipment: Can be nested to save space. Frame made of flat oval tubing. Wire platform with double edging wire. With close-meshed wire basket.
Surface finish: High-gloss galvanised, chrome-plated and transparent plastic-powder coating.
Castors: 4 swivel castors, rubber tread. Castor diameter 125 mm.

T25 transport trolley	Order no.
With wire platform	05.18570.52-V006
Load capacity (kg)	300
Weight (kg)	15

04.04 SP2 special transporter

For transporting bulky items

- > *Ergonomically designed handle*
- > *For space-saving storage*
- > *Custom trolley design*



SP2
special transporter

Quiet

Cushion roller and rubber absorber between wooden platform and frame to protect the device and reduce noise.

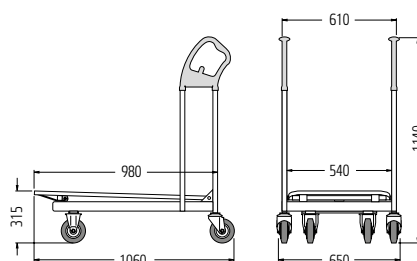

Standard equipment: Frame made of flat oval tubing, round-tube bars with ergonomically shaped handles made of shatterproof plastic. Frost- and water-resistant wooden platform with all-round protective frame made of square tube.

Surface finish: High-gloss, galvanised, chrome-plated.

Castors: 2 fixed castors, 2 swivel castors, rubber tread. Castor diameter 160 mm.

SP2 special transporter	Order no.
With wooden platform	05.20458.51-V031
Load capacity (kg)	400
Weight (kg)	28

05 Access Solutions



05 Access Solutions



Innovative access solutions

■ **For more than 50 years** the Wanzl gate and turnstiles, customer guidance systems and barriers have been a mainstay of the product range.

Innovative, high-quality Wanzl security products are used in all kinds of critical locations requiring security against unauthorised access while granting unrestricted access to authorised persons.

The hotel industry also makes use of our access solutions. Would you like to protect conference or meeting rooms from being accessed by unauthorised persons? Or would you like to have control over which guests have access to the breakfast or wellness area?

Wanzl has just the right individual and barrier-free access solutions for you. With the Galaxy Gate and Galaxy Port, we provide visually appealing access systems.

05 Access Solutions

We have a variety of access systems to suit your needs

- > *Modern design with a wide range of customisation options*
- > *Various sizes and security levels available*
- > *Barrier-free access also available*



ACCESS CONTROL to the breakfast room



PROTECTION from unauthorised access

05 Access Solutions

■ **Access solutions in the hotel increase the feeling of security for your guests** and can reduce the number of staff you need. Use access solutions from Wanzl to prevent unauthorised access to conference and meeting rooms, your wellness or breakfast area or a mini market.



Equipment

Access can take place individually via different authorisations – depending on the equipment you would like your access system to have. Your guests can, for instance, open the system by means of a barcode, QR code, RFID or NFC. We also assist you in complying with hygiene guidelines. Disinfectant dispensers or thermal imaging cameras can be integrated.



DISINFECTANT DISPENSER



THERMAL IMAGING CAMERAS

Branding

Integrate our gates optimally into your hotel.

As unique as the hotel – choose from different finishes, colours and lighting options. In addition, the side panes and swivel arms can be branded with your logo. This way, you can add your own personal touch.



Entrance and exit systems



E-GATE

GALAXY PORT

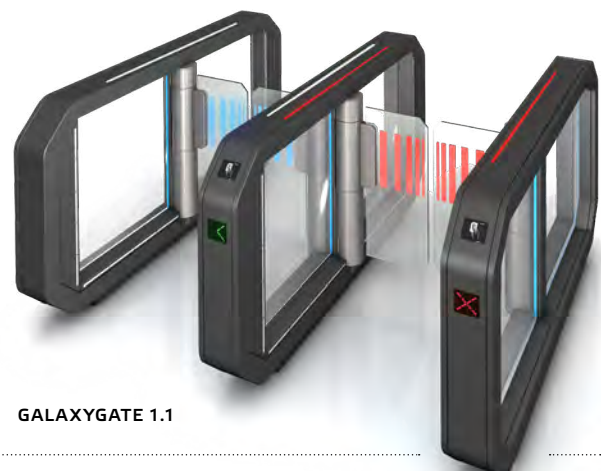

GALAXYGATE 1.1

06 Mini markets 24/7



06 Mini markets 24/7



Individual shopping options for guests

■ **Design a mini market** in the foyer of your hotel together with Wanzl! From forgotten toothbrushes to quick breakfasts with coffee and sandwiches – you can offer everything your guests desire from now on.

The store design options are endless: we plan the entire mini market for you including shelving systems, refrigerated display units, entrance systems, baked goods displays, payment systems and much more.

Self-checkout options and automated entrance systems optimise staff deployment.

Both staff-free stores and hybrid concepts are possible, which allow extended opening hours of up to 24/7.

06 Mini markets 24/7

The supermarket in the foyer of your hotel

- > Individual design for every hotel
- > Modular equipment options and product combinations
- > 24/7 usability thanks to staff-free operation



INDIVIDUAL MINI MARKET



SELF-CHECKOUT for staff-free operation

06 Mini markets 24/7

■ Use your foyer and offer your guests a supermarket for all eventualities.

Whether snacks, breakfast or forgotten hairbrushes – meet your guests' short-term needs at any time with a mini market from Wanzl.

Our competent team of interior designers and specialist planners will be happy to advise you.



FREEZER AND WASH BASIN



COFFEE STATION in the mini market

BakeOff® display

The Wanzl BakeOff display combines sophisticated design with special features to promote sales. The modern design of the units blends harmoniously with your particular lobby area. The high level of transparency of the BakeOff display gives customers a good overview of the baked goods for sale. The integrated LED lighting saves energy and presents the baked goods in an appealing light.



YourTable®

YourTable – the multifunctional presentation system with which you can easily showcase your goods professionally. The related components and accessories are designed so that they can be used in a variety of ways and combined with one another as desired. For your purposes, this means more design freedom and more target focus in the presentation of your goods.



wanzl

VISIT US AT
www.wanzl.com



GERMANY

Wanzl GmbH & Co. KGaA

Rudolf-Wanzl-Straße 4

89340 Leipheim

Phone +49(0)82 21 / 7 29-0

hotel@wanzl.com

www.wanzl.com



Dimensions in mm, specifications approximate, colours similar to RAL, design subject to changes.
Illustrations may show optional equipment. © Wanzl GmbH & Co. KGaA 2023